

Schirmleuchten Lamps with lampshades



Stehleuchte

Design: Walter Schnepel, 2006.
 Höhenverstellbarer Fuß,
 Zugschalter mit Serienschaltung
 Bestückung: 3 x E 27, 75 W
 Messing vernickelt, Fußplatte
 360/400 mm, Metall schwarz lackiert.

Floor lamp

Design: Walter Schnepel, 2006.
 Height adjustable feet,
 Pull switch with series connection
 Fitted with: 3 x E 27, 75 W
 Nickel plated brass, Base 360/400 mm,
 black lacquered metal.



Höhe stufenlos verstellbar.
 Infinitely adjustable height.

STLWS 1

Kleine Platte (360 mm)
 Small base (360 mm)

STLWS 2

Große Platte (400 mm)
 Large base (400 mm)

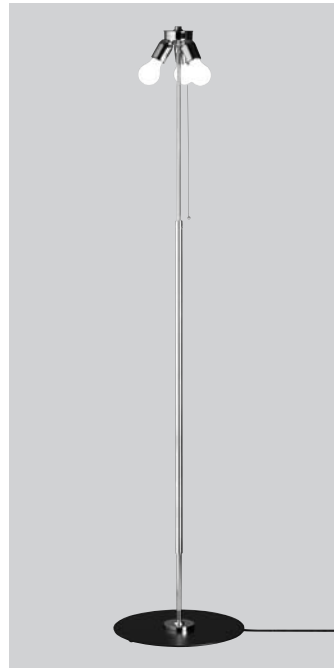

Höhe bei der Montage einstellbar.
 Height will be adjusted during assembling.

STLWS 3

Kleine Platte (360 mm)
 Small base (360 mm)

STLWS 4

Große Platte (400 mm)
 Large base (400 mm)

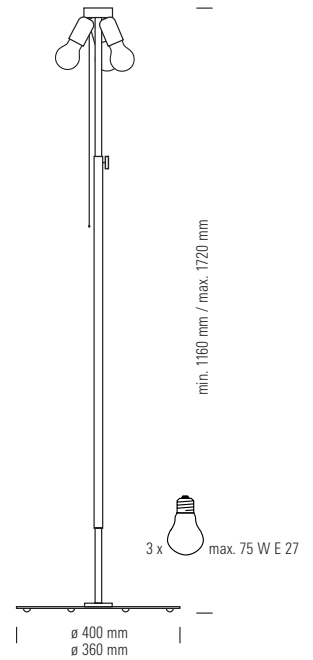

Kleine Platte (360 mm)
 Ideal für die Schirme S07/1, S07/2
 und S07/3
 Große Platte (400 mm) Ideal für
 den Schirm S07/4
 Small base (360 mm) ideal for
 Shades S07/1, S07/2 and S07/3
 Large base (400 mm) ideal for
 the shade S07/4

Pendel

Design: Walter Schnepel, 2006.
 Pendel für Stoff- oder Kunststoffschirme.
 Baldachin matt vernickelt, schwarzes
 Stoffkabel, Fassungen vernickelt.

Pendant

Design: Walter Schnepel, 2006.
 Pendant for fabric shades and for shades
 made of plastic.
 Canopy matt brushed nickel plated, black
 fabric cabel.

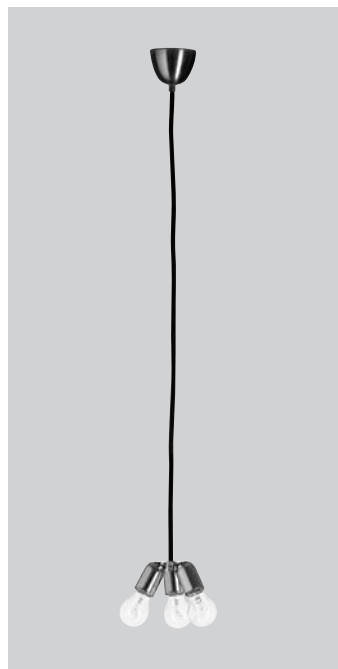
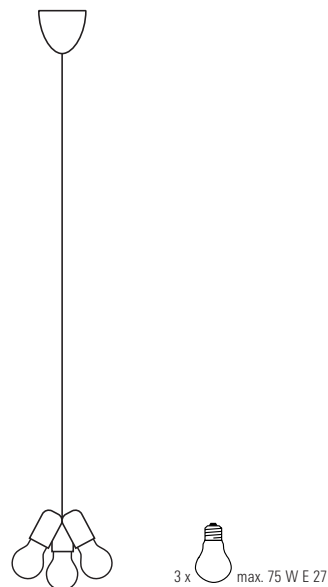
**HLWSP**

Leinenschirm auf opale oder klare, transparente Trägerfolie kaschiert. Für alle Steh- und Pendelleuchten.

Weiß
Natur
Grau
Rot
Anthrazit

Linen shade bonded on opaque or transparent film. For all Floor lamps and pendants.

White
Nature
Grey
Red
Anthracite



S 07/1 ...



S 07/2 ...

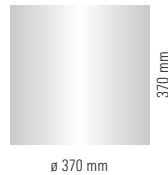

S 07/3 ...

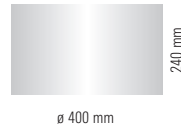

S 07/4 ...

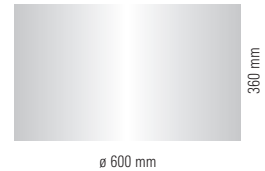

S 07/5 ...

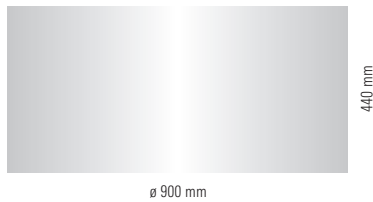

Verfügbare Stoffe:

Fabrics available:

(trotz größter reproduktionstechnischer Sorgfalt kann es bei den abgebildeten Farben zu Abweichungen vom Original kommen)



Natur (nt)
Natural (nt)



Grau (gr)
Grey (gr)



Rot (rt)
Red (rt)



Weiß (ws)
White (ws)



Anthrazit (an)
Anthracite (an)





Leinenschirme anthrazit,
auf Lackfolie kaschiert.
Für Steh- und Pendelleuchten.
Farbe der Lackfolie
Orange
Grün
Magenta
Hellblau
Rot
Weiß

Anthracite linen shades bonded
on coloured film.
For floor- and pendant lamps.
Orange
Green
Magenta
Light blue
Red
White

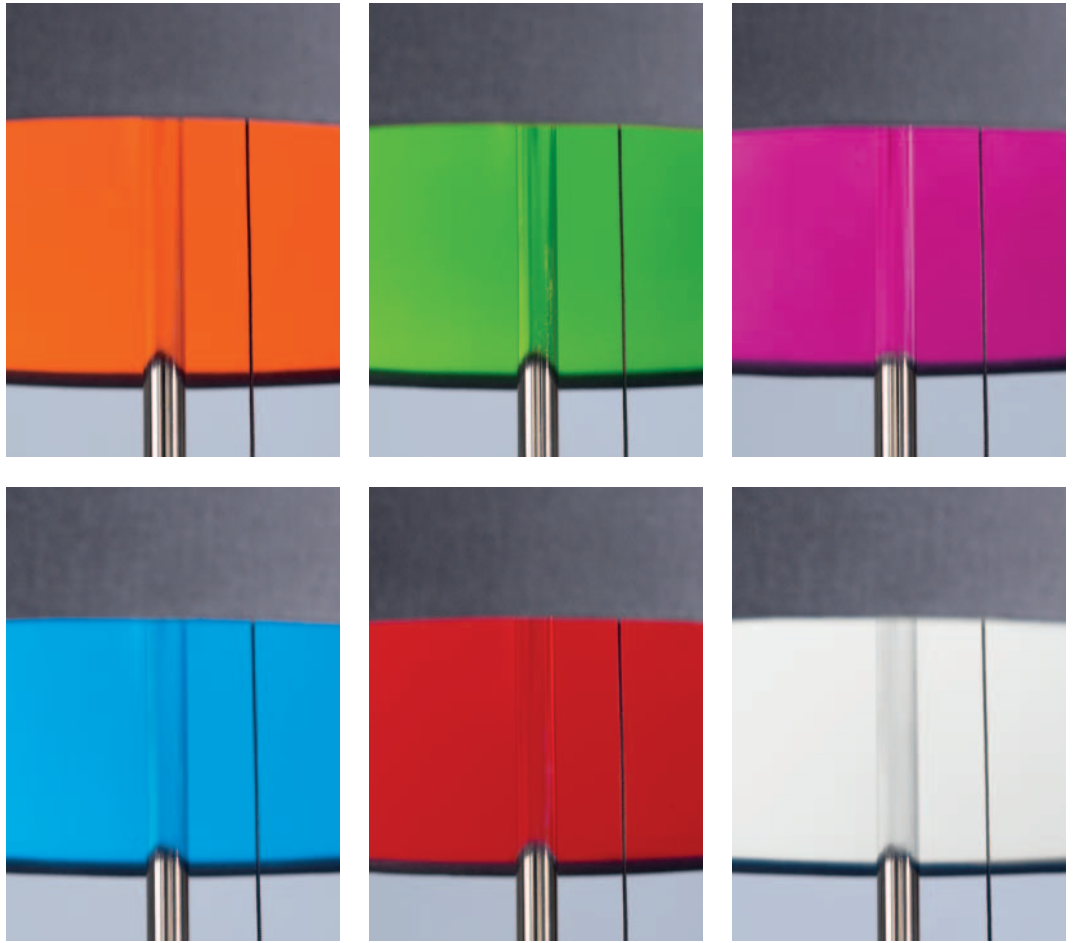

S 07/1 ...



S 07/2 ...

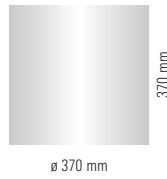

S 07/3 ...

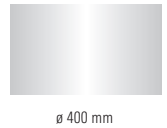

S 07/4 ...

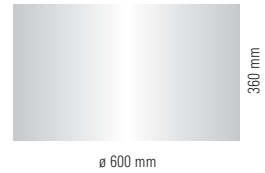

S 07/5 ...



Lackfolien-Varianten:

Variants of coloured film:
(trotz größter reproduktionstechnischer Sorgfalt kann es bei den abgebildeten Farben zu Abweichungen vom Original kommen)



Orange (... or)
Orange (... or)



Grün (... gru)
Green (... gru)



Magenta (... ma)
Magenta (... ma)



Hellblau (... hbl)
Light blue (... hbl)



Rot (... rt)
Red (... rt)

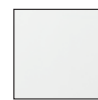

Weiß (... ws)
White (... ws)

Die Schirme mit dem Edeltstahlgewebe können alleine, aber auch mit Stoffschirmen (Edelstahl-Geflecht einfach) kombiniert werden.

Bei der rechten Pendelleuchte wurde der große Edelstahlschirm (S07/4 V2A) über den kleinen roten Stoffschirm (S07/3rt) gehängt.

The shades with the stainless steel mesh can be used alone or else combined with fabric shades (stainless steel mesh).
On the pendant lamp on the right the large stainless steel shade (S07/4 V2A) has been attached above the small red fabric (S07/3rt).



S 07/2 V2A
S 07/2 V2A D = doppelt

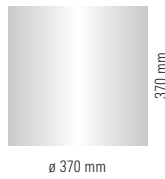

S 07/4 V2A
S 07/4 V2A D = doppelt

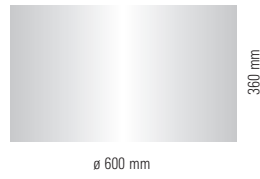



Diffusor

Diffusor für Pendelleuchten mit Stoffschirm.

Diffusor

Diffusor for pendant lamps with fabric shades.

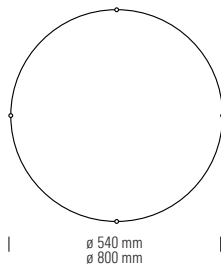
DIF 4 (für Pendelleuchten-Schirme S 07/4 ...)**DIF 5 (für Pendelleuchten-Schirme S 07/5 ...)****Schnurdimmer**

Schnurdimmer für Stehleuchten STLWS ...

Cable dimmer

Cable dimmer for Floor lamps STLWS ...

DIM**Alternativ zur E 27-Fassung:****Bausätze mit elektronischem****Vorschaltgerät (EVG)**

(nur für Pendelleuchten ab $\varnothing 60 \text{ cm}$)

Mit EVG's für 2 Kompakt-Leuchtstofflampen 18 W.

Mit EVG's für 2 Kompakt-Leuchtstofflampen 26 W, 32 W oder 42 W.

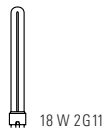





Tischleuchte

Material: Messing vernickelt,
Zuleitung stoffummantelt, schwarz.
Stoffschild: Leinen kaschiert
auf Transparentfolie.
Bestückung: E 27, max. 75 W.

Table lamp

Material: Brass nickel plated,
black cloth lead.
Shade fabric: linen bonded
on a transparent film.
Fitted with: E 27, max. 75 W.



TLWS 05 ...

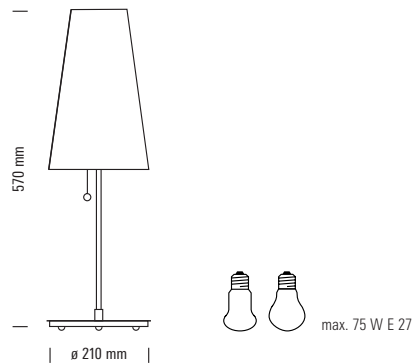

TLWS 06 ...

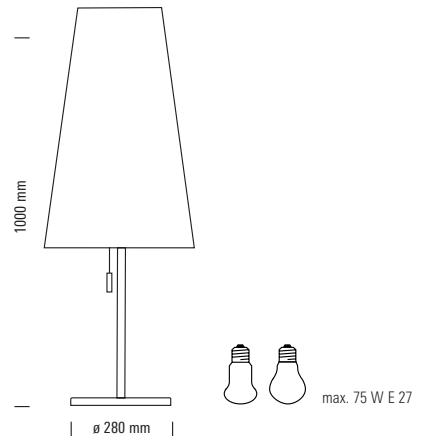

Verfügbare Stoffe:

Fabrics available:

(trotz größter reproduktionstechnischer Sorgfalt kann es bei den abgebildeten Farben zu Abweichungen vom Original kommen)



Natur (nt)
Natural (nt)



Grau (gr)
Grey (gr)



Rot (rt)
Red (rt)



Weiß (ws)
White (ws)



Anthrazit (an)
Anthracite (an)

Pendelleuchte

Material: Messing matt vernickelt,
 Pendelleitung stoffummantelt, schwarz.
 Stoffschirm: Leinen kaschiert
 auf Transparentfolie.
 Bestückung: E 27, max. 75 W.

Pendant lamp

Material: Brass matt nickel,
 Pendant lamp black cloth lead.
 Shade fabric: linen bonded
 on transparent film.
 Fitted with: E 27, max. 75 W.

Design: W. Schnepel, 2005.



HLWS 05 ...

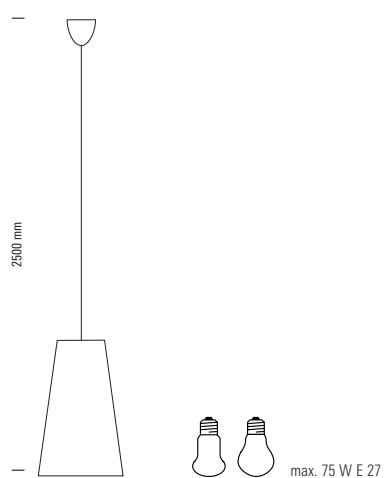

HLWS 06 ...

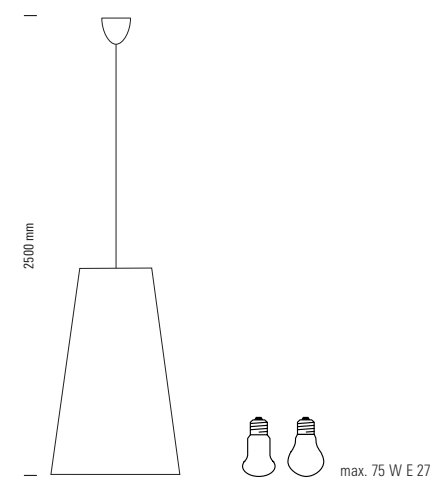
**Verfügbare Stoffe:**

Fabrics available:

(trotz größter reproduktionstechnischer Sorgfalt kann es bei den abgebildeten Farben zu Abweichungen vom Original kommen)



Natur (nt)
 Natural (nt)



Grau (gr)
 Grey (gr)



Rot (rt)
 Red (rt)



Weiß (ws)
 White (ws)



Anthrazit (an)
 Anthracite (an)



TECNOLUMEN GmbH & Co. KG

Postanschrift:

Postfach 11 05 28, D-28085 Bremen

Lieferanschrift:

Lötzeener Str. 2–4, D-28207 Bremen

Telefon (0421) 43 04 17-0

Telefax (0421) 4 98 66 85

www.tecnolumen.de

info@tecnolumen.de