

Trattoria Tavolo design Jasper Morrison • image p-152

Tables.

Year of production: 2010.

Material: frame in natural solid beech. Top in HPL laminate.

Mesas.

Año de producción: 2010.

Material: estructura en madera maciza de haya natural. Sobre en laminado HPL.

Tables.

Année de production: 2010.

Matériaux: structure en hêtre massif naturel. Plateau en laminé HPL.

Tische.

Erstproduktion: 2010.

Material: Gestell aus massiver Buche, naturfarben. Tischplatte aus HPL-Laminat.

Tavoli.

Anno di produzione: 2010.

Materiali: struttura in massello di faggio naturale. Piano in laminato HPL.

TOP FINISHES

○ white 5108

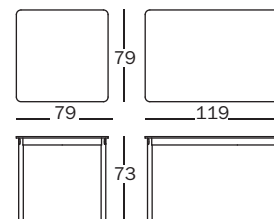
Steelwood Chair design Ronan & Erwan Bouroullec • image p-158

Chair with arms.

Year of production: 2008.

Material: seat and legs in solid beech, natural or painted. Frame in steel plate painted in epoxy resin.

Silla con brazos.

Año de producción: 2008.

Material: asiento y patas en madera maciza de haya natural o barnizada.

Estructura en laminas de acero barnizado epoxi.

Chaise avec accoudoirs.

Année de production: 2008.

Matériaux: assise et pieds en hêtre massif naturel ou teinté. Structure en tôle d'acier verni en résine époxy.

Stuhl mit Armlehnen.

Erstproduktion: 2008.

Material: Sitz und Beine aus massiver Buche, naturfarben oder lackiert. Rückenlehne aus epoxylackiertem Stahlblech.

Sedia con braccioli.

Anno di produzione: 2008.

Materiali: sedile e gambe in massello di faggio naturale o verniciato, struttura di lamiera di acciaio verniciato con resina epossidica.

COUPLINGS

- red 5083 (frame)
- beech painted red (seat and legs)
- white 5108 (frame)
- beech painted white (seat and legs)
- white 5108 (frame)
- natural beech 7011 (seat and legs)
- black 5140 (frame)
- beech painted black (seat and legs)

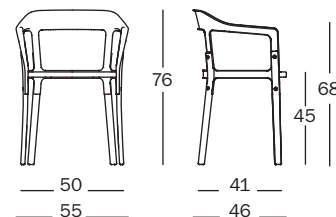

Steelwood Stool design Ronan & Erwan Bouroullec • image p-172

Stools.

Year of production: 2010.

Material: seat and foot-rest in steel plate painted in epoxy resin. Legs in solid beech, natural or painted.

Taburetes.

Año de producción: 2010.

Material: asiento y reposapiés en laminas de acero barnizado epoxi. Patas en madera maciza de haya natural o barnizada.

Tabourets.

Année de production: 2010.

Matériaux: assise et repose-pieds en tôle d'acier verni en résine époxy. Pieds en hêtre massif naturel ou teinté.

Hocker.

Erstproduktion: 2010.

Material: Sitz und Fußstütze aus epoxylackiertem Stahlblech. Beine aus massiver Buche, naturfarben oder lackiert.

Sgabelli.

Anno di produzione: 2010.

Materiali: seduta e poggiatesta in lamiera di acciaio verniciata in resina epossidica, gambe in massello di faggio naturale o verniciato.

COUPLINGS

● red 5083 (seat)
● beech painted red (legs)

○ white 5108 (seat)
○ beech painted white (legs)

○ white 5108 (seat)
● natural beech 7011 (legs)

● black 5140 (seat)
● beech painted black (legs)

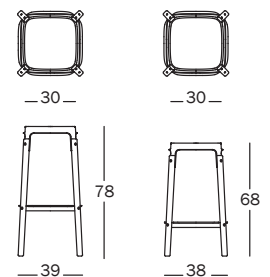
Steelwood Table design Ronan & Erwan Bouroullec • image p-164

Tables system.

Year of production: 2009.

Material: frame (legs and crosspieces) in solid beech, natural or painted.

Top in HPL laminate.

Joints in steel plate painted in epoxy resin.

Sistema di tavoli.

Anno di produzione: 2009.

Materiali: struttura (gambe e traversi) in massello di faggio naturale o verniciato.

Piano in laminato HPL.

Giunti in lamiera di acciaio verniciata in resina epossidica.

Sistema de mesas.

Año de producción: 2009.

Material: estructura (patas y travesaño) en madera maciza de haya natural o barnizada.

Sobre en laminado HPL.

Juntas en laminas de acero barnizado epoxi.

Système de tables.

Année de production: 2009.

Matériaux: structure (pieds et traverses) en hêtre massif naturel ou teinté.

Plateau en laminé HPL.

Joints en tôle d'acier verni en résine époxy.

Tischsystem.

Erstproduktion: 2009.

Material: Gestell (Beine und Querstreben) aus massiver Buche, naturfarben oder lackiert.

Tischplatte aus HPL-Laminat. Verbindungsgelenke aus Stahlblech, epoxylackiert.

COUPLINGS:

○ white 5108 (frame)
○ beech painted white (joints and tops)

● black 5140 (frame)
● beech painted black (joints and tops)

● natural beech 7011 (frame)
○ white 5108 (joints and tops)

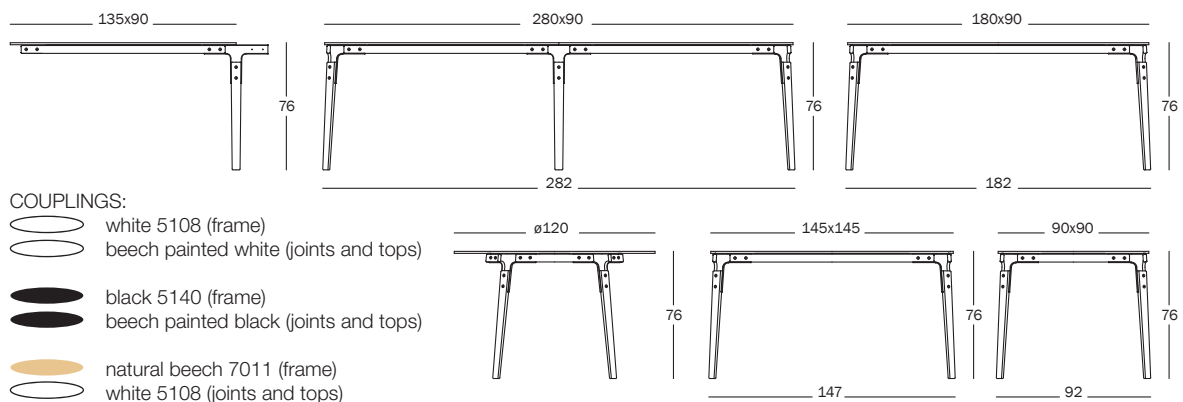

Steelwood Shelving System design Ronan & Erwan Bouroullec • image p-164

Shelving system.

Year of production: 2009.

Material: frame (upright and crosspieces) in solid beech, natural or painted.

Joints in steel plate painted in epoxy resin.

Shelves in painted MDF.

Librería modular.

Año de producción: 2009.

Material: estructura (travesaño vertical) en madera maciza de haya natural o barnizada.

Juntas en laminas de acero barnizado epoxi.

Estantes en MDF barnizado.

Étagère modulaire.

Année de production: 2009.

Matériaux: structure (montants et traverses) en hêtre massif naturel ou teinté.

Joints en tôle d'acier verni en résine époxy.

Plateaux en MDF verni.

Modulares Regalsystem.

Erstproduktion: 2009.

Material: Gestell (Pfeiler und Querstreben) aus massiver Buche, naturfarben oder lackiert.

Verbindungsgelenke aus Stahlblech, epoxylackiert.

Bretter aus lackiertem MDF.

Libreria modulare.







Anno di produzione: 2009.

Materiali: struttura (montanti e traversi) in massello di faggio naturale o verniciato.

Giunti in lamiera di acciaio verniciata in resina epossidica.

Ripiani in MDF verniciato.

COUPLINGS:

-  white 5108 (frame)
-  beech painted white (joints and shelves)
-  black 5140 (frame)
-  beech painted black (joints and shelves)
-  natural beech 7011 (frame)
-  white 5108 (joints and shelves)

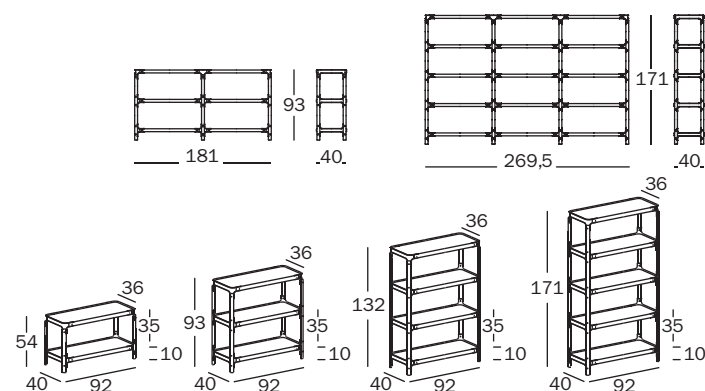
Steelwood Coat Stand design Ronan & Erwan Bouroullec • image p-170

Coat stand.

Year of production: 2010.

Material: frame in solid beech, natural or painted. Joints in steel plate painted in epoxy resin.

Percha de pie.

Año de producción: 2010.

Material: estructura en madera maciza de haya natural o barnizada. Juntas en laminas de acero barnizado epoxi.

Porte manteaux.

Année de production: 2010.

Matériaux: structure en hêtre massif naturel ou teinté. Joints en tôle d'acier verni en résine époxy.

Kleiderständer.

Erstproduktion: 2010.







Material: Gestell aus massiver Buche, naturfarben oder lackiert. Verbindungsgelenke aus epoxylackiertem Stahlblech.

Appendiabiti.

Anno di produzione: 2010.

Materiali: struttura in massello di faggio naturale o verniciato, elementi di giunzione in lamiera di acciaio verniciata in resina epossidica.

COUPLINGS:

-  beech painted white (frame)
-  white 5108 (joints)
-  beech painted black (frame)
-  black 5140 (joints)
-  white 5108 (frame)
-  natural beech 7011 (joints)

